



Straumann® Novaloc® Retentive System for Hybrid Dentures

Basic Information

Contents

1. The Novaloc® Retentive System for hybrid dentures	1
1.1 Straumann® Novaloc® Retentive System at a glance	1
1.2 Overview of Novaloc® abutment and matrix dimensions	2
2. Creating a new overdenture with the Novaloc® Retentive System	4
2.1 Procedure in the dental office	4
2.2 Procedure in the dental lab	5
2.3 Procedure in the dental office	7
3. Using the Novaloc® Tools	8
3.1 Novaloc® Matrix Housing Extraction Instrument	8
3.2 Novaloc® Processing Insert Removal Instrument	8
3.3 Novaloc® Retention Insert Instrument	9
4. Special featured Novaloc® Components	10
5. Product reference list	11
6. Appendix	18
6.1 Appendix A	18
6.2 Appendix B	20

1. The Novaloc[®] Retentive System for hybrid dentures

The Straumann[®] Novaloc[®] Retentive System for hybrid dentures offers an innovative carbon-based abutment coating (ADLC¹) with an excellent wear resistance, overcoming up to 60° implant divergence. Both the straight and 15° angled abutments are available in various abutment heights, covering a broad range of clinical implant situations. Together with its durable PEEK² matrices, the Novaloc[®] Retentive System provides a unique and long-lasting attachment performance.

1.1 Straumann[®] Novaloc[®] Retentive System at a glance

- 1 – PEEK² retention inserts offering excellent chemical and physical properties
 - Matrix accommodates up to 40° prosthetic divergence between two abutments
 - 6 retention strengths offer optimal adjustment of the denture retention
 - Matrix Housing available in titanium, or color-neutral PEEK² for a more aesthetic outcome
- 2 – Carbon-based abutment coating (ADLC¹) offering a smooth surface and ultimate hardness
 - for lasting wear resistance
- 3 – Compatible to the standard SCS Screwdriver
 - self-retaining system preventing aspiration
 - small stud hole prevents food accumulation
- 4 – Compatible to the standard SCS Screwdriver
 - self-retaining system preventing aspiration
- 5 – 6 abutment heights for Novaloc[®] straight abutment³
- 6 – 5 abutment heights for Novaloc[®] angled abutment⁴
- 7 – Laser-marked abutment height and implant platform
 - Rely on the original implant-abutment connection
 - perfectly matching components
 - excellent service and support

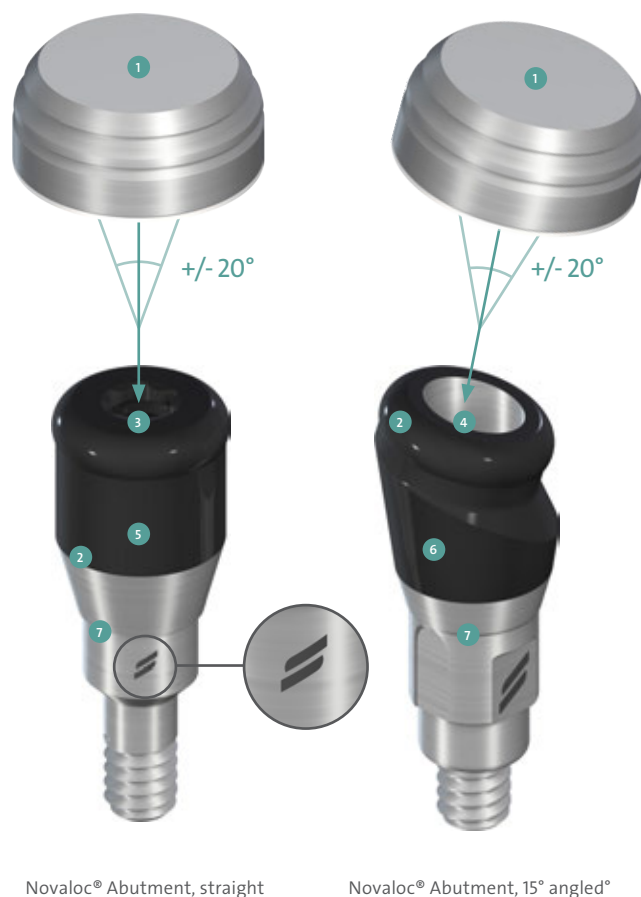

CrossFit[®]:

Two types of CrossFit[®] Novaloc[®] angled abutments are available, type A and type B. This enables the axis to be corrected in 8 different alignments (in 45° graduations).

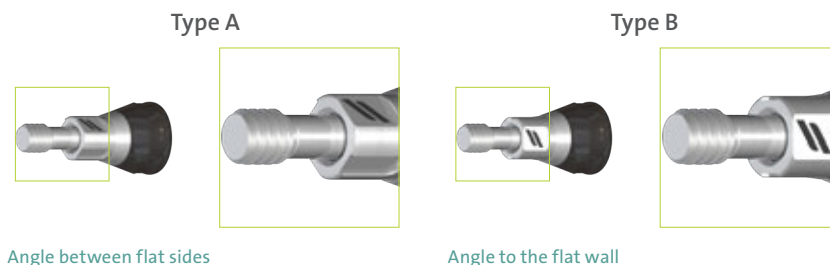

¹ Amorphous Diamond-Like Carbon

² Polyether ether ketone

³ 1.5 to 6.5 mm for BLX, 1 to 6 mm for all other systems

⁴ 6 lengths: 2.5 to 7.5 mm for BLX, 2 to 6 mm for all other systems

1.2 Overview of Novaloc® abutment and matrix dimensions

Novaloc® Matrix Dimensions

	A	H
Novaloc® Matrix	2.3	1.4



TL, TLX Novaloc® Straight Abutment Dimensions

		B	C
TL NNC, TLX NT	Novaloc® H1	1.35	2.75
	Novaloc® H2	2.35	3.75
	Novaloc® H3	3.35	4.75
	Novaloc® H4	4.35	5.75
	Novaloc® H5	5.35	6.75
	Novaloc® H6	6.35	7.75
TL RN, TLX RT	Novaloc® H1	1.5	2.9
	Novaloc® H2	2.5	3.9
	Novaloc® H3	3.5	4.9
	Novaloc® H4	4.5	5.9
	Novaloc® H5	5.5	6.9
	Novaloc® H6	6.5	7.9
TL WN, TLX WT	Novaloc® H1	1.7	3.1
	Novaloc® H2	2.7	4.1
	Novaloc® H3	3.7	5.1
	Novaloc® H4	4.7	6.1
	Novaloc® H5	5.7	7.1
	Novaloc® H6	6.7	8.1

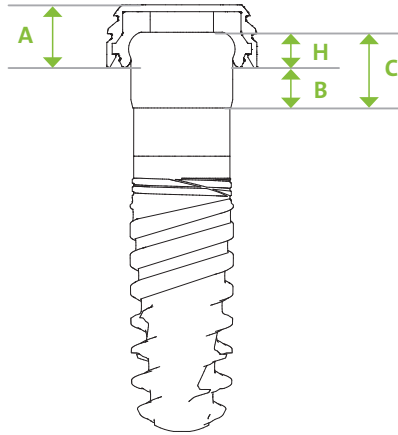

TL, TLX Novaloc® Angled Abutment Dimensions

		Short side		Long side	
		D	E	F	G
TL NNC, TLX NT	Novaloc® H2	1.8	3.2	2.7	4.1
	Novaloc® H3	2.7	4.1	3.7	5.1
	Novaloc® H4	3.7	5.1	4.6	6.0
	Novaloc® H5	4.7	6.1	5.6	7.0
	Novaloc® H6	5.6	7.0	6.6	8.0
	TL RN, TLX RT	Novaloc® H2	1.8	3.2	3.0
Novaloc® H3		2.7	4.1	4.0	5.4
Novaloc® H4		3.7	5.1	5.0	6.4
Novaloc® H5		4.7	6.1	5.9	7.3
Novaloc® H6		5.6	7.0	6.9	8.3
TL WN, TLX WT		Novaloc® H2	1.8	3.2	3.5
	Novaloc® H3	2.7	4.1	4.4	5.8
	Novaloc® H4	3.7	5.1	5.4	6.8
	Novaloc® H5	4.7	6.1	6.4	7.8
	Novaloc® H6	5.6	7.0	7.3	8.7

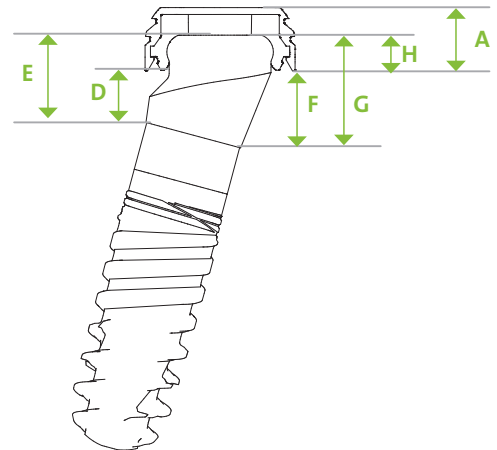

1.2.1 BL/BLT, BLX Novaloc® Abutment Dimensions

BL/BLT NC					
Angle		0°	15°		
GH	1 mm	022.0046	–	S	L
	2 mm	022.0047	022.0062/ 022.0072	1.5 mm	2.3 mm
	3 mm	022.0048	022.0063/ 022.0073	2.5 mm	3.2 mm
	4 mm	022.0049	022.0064/ 022.0074	3.5 mm	4.2 mm
	5 mm	022.0050	022.0065/ 022.0075	4.4 mm	5.2 mm
	6 mm	022.0051	022.0066/ 022.0076	5.4 mm	6.1 mm

BL/BLT RC					
Angle		0°	15°		
GH	1 mm	022.0052	–	S	L
	2 mm	022.0053	022.0067/ 022.0077	1.2 mm	2.1 mm
	3 mm	022.0054	022.0068/ 022.0078	2.2 mm	3.1 mm
	4 mm	022.0055	022.0069/ 022.0079	3.2 mm	4.1 mm
	5 mm	022.0056	022.0070/ 022.0080	4.1 mm	5.1 mm
	6 mm	022.0057	022.0071/ 022.0081	5.1 mm	6.1 mm

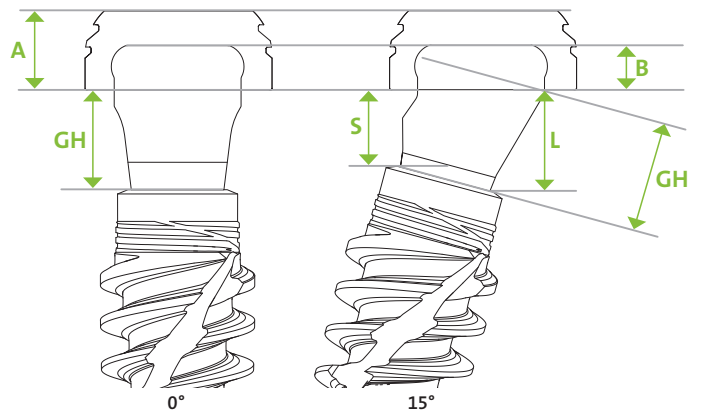

BLX RB/WB					
Angle		0°	15°		
GH	1.5 mm	062.4501	–	S	L
	2.5 mm	062.4502	062.4507	1.2 mm	1.9 mm
	3.5 mm	062.4503	062.4508	2.2 mm	2.9 mm
	4.5 mm	062.4504	062.4509	3.2 mm	3.9 mm
	5.5 mm	062.4505	062.4510	4.2 mm	4.9 mm
	6.5 mm	062.4506	062.4511	5.2 mm	5.9 mm
	7.5 mm	–	062.4512	6.2 mm	6.9 mm

2. Creating a new overdenture with the Novaloc® Retentive System

2.1 Procedure in the dental office

2.1.1 Selecting Novaloc® Abutment height



Step 1 – Selecting the abutment

- Ensure that the implant shoulder is not covered by hard or soft tissue
- Determine the appropriate abutment height by counting the marks on the Novaloc® Plan Abutments*.



Step 2 – Inserting the Abutment

- Screw the Novaloc® Abutment tightly by hand into the implant using the Straumann® SCS Screwdriver.
- Torque the abutment to 35 Ncm using the Ratchet, the Torque Control Device and the SCS Screwdriver.

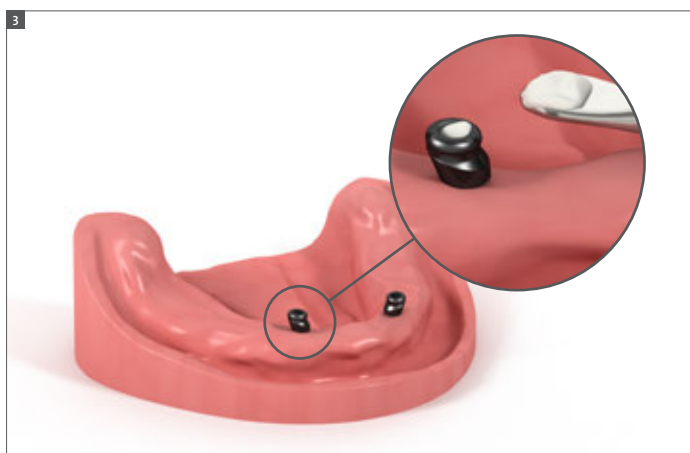

Step 3 – Sealing the screw channel of the Novaloc® Angled Abutment

- Use Teflon and composite in order to seal the screw channel of the Novaloc® Angled Abutment. Ensure that the composite is planar to the abutment.

Note:

A uniform horizontal height of all Novaloc® Abutments makes it easier for the patient to insert the prosthesis.

* not available for RB/WB.

2.1.2 Impression taking – abutment level



Step 1 – Placing the Novaloc® Impression Coping

- Place the Impression Coping on the Novaloc® Abutment.



Step 2 – Impression taking

- Use the mucodynamic technique for impression taking (vinyl polysiloxane or polyether rubber).
- Send the impression to the dental lab.

2.2 Procedure in the dental lab

2.2.1 Master cast – abutment-level impression



Step 1 – Inserting the Novaloc® Model Analog

- Insert the Novaloc® Model Analog into the Novaloc® Impression Coping (see chapter 3 Using the Novaloc® Tools). For straight abutments use the straight, for angled abutments the angled analog.



Step 2 – Fabricating the master cast

- Pour a master model using standard methods and type-4 dental stone (DIN 6873).

Note:

The master model can also be created with an implant-level impression.

2.2.2 Finalizing the new Novaloc® overdenture



Step 1 – Placing the Novaloc® Processing Collar and Matrix Housing

- Place white Processing Collars on all Novaloc® Model Analogs.
- Place the Matrix Housing incl. preassembled Processing Insert onto the Novaloc® Abutments.

Note:

For a chair-side polymerization of the Novaloc® Matrix Housing use the Novaloc® Block Out Spacer to create the space needed.



Step 2 – Processing the overdenture

- Process the overdenture according to standard procedures.
- The dental lab will return the finalized Novaloc® overdenture to the dental office including the Processing Inserts in place.

2.3 Procedure in the dental office

2.3.1 Seating the new Novaloc® overdenture

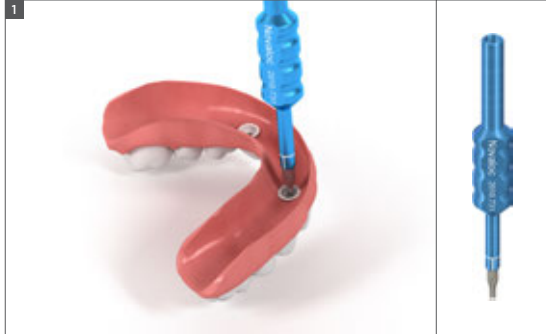

Step 1 – Removing the Novaloc® Processing Insert

- Remove all Processing Inserts from the Matrix Housing using the Processing Insert Removal Instrument (blue) (see chapter 3 Using the Novaloc® Tools).

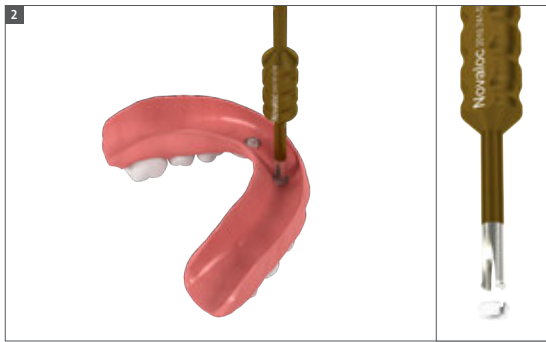

Step 2 – Selecting and inserting the Novaloc® Retention Inserts

- Select the appropriate Novaloc® Retention Insert (see chapter 4 Special featured Novaloc® components).
- Insert the Novaloc® Retention Inserts to the Matrix Housing using the Retention Insert Instrument (brown) (see chapter 3 Using the Novaloc® Tools).



Step 3 – Seating the finished overdenture

- Seat the finished overdenture and check the occlusion.

3. Using the Novaloc® Tools

3.1 Novaloc® Matrix Housing Extraction Instrument (Fig. 1)

Removing the Novaloc® Matrix Housing from an overdenture

1. Heat the Novaloc® Matrix Housing Extraction Instrument head (Fig. 2).
2. Apply the hot Novaloc® Matrix Housing Extraction Instrument to the Matrix Housing and let the heat transfer for 2–3 seconds melting the resin around the Matrix Housing.
3. Tilt the Novaloc® Matrix Housing Extraction Instrument to the opposite side of the beak-shape end in order to remove the Novaloc® Matrix Housing (Fig. 3).

3.2 Novaloc® Processing Insert Removal Instrument (Fig. 4)

Removing the Novaloc® Processing Insert

1. Insert the toe of the Novaloc® Processing Insert Removal Instrument into the Novaloc® Processing Insert (Fig. 5).
2. Tip the Novaloc® Processing Insert Removal Instrument to the opposite side of the foot-shaped end and remove the Novaloc® Processing Insert from the Novaloc® Matrix Housing (Fig. 6).

Placing the Novaloc® Model Analog

1. Pick up the Novaloc® Model Analog with the opposite side of the Novaloc® Processing Insert Removal Instrument (Fig. 7/8).
2. Position the Novaloc® Model Analog in the impression (Fig. 9).

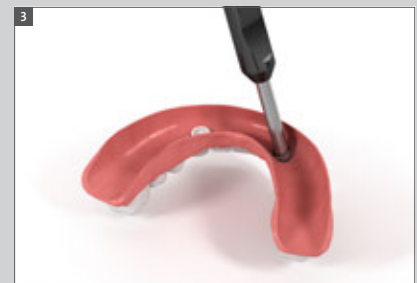
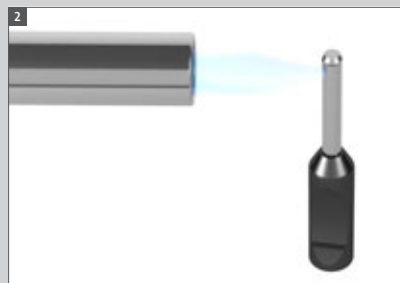

3.3 Novaloc® Retention Insert Instrument (Fig. 11)

Mounting the Novaloc® Retention Insert

1. Pick up the Novaloc® Retention Insert with the gripper end of the Novaloc® Retention Insert Instrument. The Novaloc® Retention Insert will lock on to the tool (Fig. 12).
2. Place the Novaloc® Retention Insert into the Novaloc® Matrix Housing (Fig. 13). The Novaloc® Retention Insert “clicks” into position (Fig. 14).

Demounting the Novaloc® Retention Insert

1. Apply the plunger end of the Novaloc® Retention Insert Instrument to the Novaloc® Retention Insert and engage with light pressure (Fig. 15/16).
2. Remove the Novaloc® Retention Insert from the Novaloc® Matrix Housing using a slight rotational movement (Fig. 17).
3. Use the special indentation in the handle of the Novaloc® Matrix Housing Extraction Instrument (Fig. 1) to remove the Novaloc® Retention Insert from the Novaloc® Retention Insert Instrument with a tilting movement (Fig. 18/19).

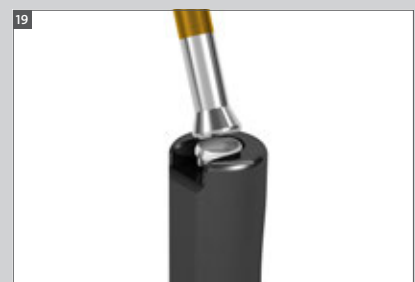
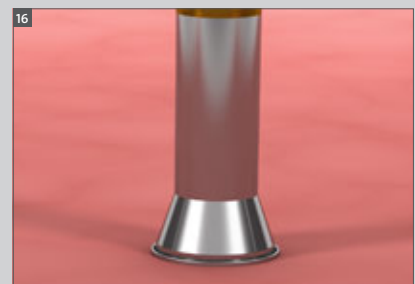
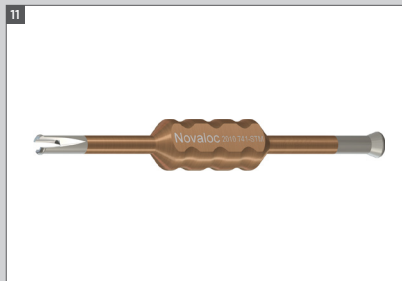

4. Special featured Novaloc® Components



Novaloc® Retention Inserts

The Novaloc® Matrix System allows for a prosthetic insertion of up to +/- 20° divergence, meaning 40° between two Novaloc® Abutments.

Note:

It is recommended to use the light retention force first (white). In case it feels too loose for the patient, exchange with inserts with a higher retention force.



Novaloc® Processing Collar

The Processing Collar blocks out the area surrounding the abutment, preventing that resin or a bonding agent flows into the Matrix Housing and imbedding the abutment.



Novaloc® Matrix Housing, PEEK

The neutral-colored PEEK Matrix Housing is used for extremely labial or buccal implant positions preventing grey irritation coming from a titanium Matrix Housing.

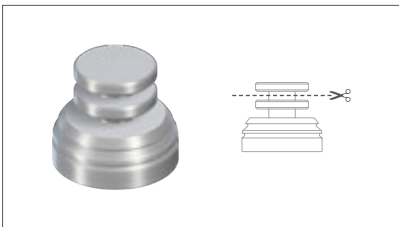

Novaloc® Matrix Housing - Extended option

This Matrix Housing offers an extended attachment option. It is used for low-lying abutment heights or in situations requiring more retention. The attachment may be shortened according the required height.



Novaloc® Processing Insert

The Novaloc® Processing Insert protects the interior of the Novaloc® Matrix Housing and keeps it in place during processing. Furthermore, it also prevents any resin or bonding agents of entering into the Novaloc® Matrix Housing during fixation.



Novaloc® Block Out Spacer

The Novaloc® Block Out Spacer is a placeholder for the Novaloc® Matrix Housing. It is used for the model-cast, cast metal-reinforced denture or if the Novaloc® Matrix Housing shall be polymerized into the overdenture chair-side.



5. Product reference list

Straumann® Novaloc® Abutment, straight, 0°*				
	Art. No.	Description	Gingiva height	Material
	048.812	RN Novaloc® Abutment, 0°	1 mm	Titanium Gr 5/ADLC
	048.813		2 mm	
	048.814		3 mm	
	048.815		4 mm	
	048.816		5 mm	
	048.817		6 mm	
	048.818	WN Novaloc® Abutment, 0°	1 mm	
	048.819		2 mm	
	048.820		3 mm	
	048.821		4 mm	
	048.822		5 mm	
	048.823		6 mm	
	048.806	NNC Novaloc® Abutment, 0°	1 mm	
	048.807		2 mm	
	048.808		3 mm	
	048.809		4 mm	
	048.810		5 mm	
	048.811		6 mm	
	022.0046	NC Novaloc® Abutment, 0°	1 mm	
	022.0047		2 mm	
	022.0048		3 mm	
	022.0049		4 mm	
	022.0050		5 mm	
	022.0051		6 mm	
	022.0053	RC Novaloc® Abutment, 0°	2 mm	
	022.0054		3 mm	
	022.0055		4 mm	
	022.0056		5 mm	
	022.0057		6 mm	
	062.4501	RB/WB Novaloc® Abutment Ø3.8, 0°	1.5 mm	
	062.4502		2.5 mm	
	062.4503		3.5 mm	
	062.4504		4.5 mm	
	062.4505		5.5 mm	
	062.4506		6.5 mm	

ADLC = Amorphous Diamond-Like Carbon

* Manufacturer
 Institut Straumann AG
 Peter Merian-Weg 12, 4002 Basel
 Switzerland

Not all products are available in all countries.







	Art. No.	Description	Gingiva height	Material
	037.0500	NT Novaloc® ADLC, straight 0°	1 mm	Titanium Gr 5/ADLC
	037.0501		2 mm	
	037.0502		3 mm	
	037.0503		4 mm	
	037.0504		5 mm	
	037.0505		6 mm	
	037.1500	RT Novaloc® ADLC, straight 0°	1 mm	
	037.1501		2 mm	
	037.1502		3 mm	
	037.1503		4 mm	
	037.1504		5 mm	
	037.1505		6 mm	
	037.2500	WT Novaloc® ADLC, straight 0°	1 mm	
	037.2501		2 mm	
	037.2502		3 mm	
	037.2503		4 mm	
	037.2504		5 mm	
	037.2505		6 mm	

ADLC = Amorphous Diamond-Like Carbon

* Manufacturer
 Institut Straumann AG
 Peter Merian-Weg 12, 4002 Basel
 Switzerland

Not all products are available in all countries.

Straumann® Novaloc® Abutment, angled, 15°*



	Art. No.	Description	Gingiva height	Material
	048.832	RN Novaloc® Abutment, 15°	2 mm	Titanium Gr 5/ADLC
	048.833		3 mm	
	048.834		4 mm	
	048.835		5 mm	
	048.836		6 mm	
	048.837	WN Novaloc® Abutment, 15°	2 mm	
	048.838		3 mm	
	048.839		4 mm	
	048.840		5 mm	
	048.841		6 mm	
	062.4507	RB/WB Novaloc® Abutment Ø3.8, 15°	2.5 mm	
	062.4508		3.5 mm	
	062.4509		4.5 mm	
	062.4510		5.5 mm	
	062.4511		6.5 mm	
	062.4512		7.5 mm	
	037.1510	RT Novaloc® ADLC, angled 15°	2 mm	
	037.1511		3 mm	
	037.1512		4 mm	
	037.1513		5 mm	
	037.1514		6 mm	
	037.1510	RT Novaloc® ADLC, angled 15°	2 mm	
	037.1511		3 mm	
	037.1512		4 mm	
	037.1513		5 mm	
	037.1514		6 mm	
	037.2510	WT Novaloc® ADLC, angled 15°	2 mm	
	037.2511		3 mm	
	037.2512		4 mm	
	037.2513		5 mm	
	037.2514		6 mm	

ADLC = Amorphous Diamond-Like Carbon



* Manufacturer
 Institut Straumann AG
 Peter Merian-Weg 12, 4002 Basel
 Switzerland

Not all products are available in all countries.

Straumann® Novaloc® Abutment, angled, 15° | Type A*

	Art. No.	Description	Gingiva height	Material
	048.842	NNC Novaloc® Abutment, 15°	2 mm	Titanium Gr 5/ADLC
	048.843		3 mm	
	048.844		4 mm	
	048.845		5 mm	
	048.846		6 mm	
	022.0062	NC Novaloc® Abutment, 15°	2 mm	
	022.0063		3 mm	
	022.0064		4 mm	
	022.0065		5 mm	
	022.0066		6 mm	
	022.0067	RC Novaloc® Abutment, 15°	2 mm	
	022.0068		3 mm	
	022.0069		4 mm	
	022.0070		5 mm	
	022.0071		6 mm	





Straumann® Novaloc® Abutment, angled, 15° | Type B*

	Art. No.	Description	Gingiva height	Material
	048.847	NNC Novaloc® Abutment, 15°	2 mm	Titanium Gr 5/ADLC
	048.848		3 mm	
	048.849		4 mm	
	048.850		5 mm	
	048.851		6 mm	
	022.0072	NC Novaloc® Abutment, 15°	2 mm	
	022.0073		3 mm	
	022.0074		4 mm	
	022.0075		5 mm	
	022.0076		6 mm	
	022.0077	RC Novaloc® Abutment, 15°	2 mm	
	022.0078		3 mm	
	022.0079		4 mm	
	022.0080		5 mm	
	022.0081		6 mm	



Straumann® Novaloc® Bar Abutment

	Art. No.	Description	Gingiva height	Material
	048.857V2	Novaloc® Bar Abutment	N/A	Titanium Gr 5/ADLC



Straumann® Novaloc® Plan Abutments, straight, 0°

	Art. No.	Description	Compatibility with Novaloc® Abutments
	048.280V4*	RN Novaloc® Plan Abutment, H 1-6 mm, POM	048.812, 048.813, 048.814, 048.815, 048.816, 048.817
	048.852V4*	WN Novaloc® Plan Abutment, H 1-6 mm, POM	048.818, 048.819, 048.820, 048.821, 048.822, 048.823
	048.951V4*	NNC Novaloc® Plan Abutment, H 1-6 mm, POM	048.806, 048.807, 048.808, 048.809, 048.810, 048.811
	025.2646-04*	NC Novaloc® Plan Abutment, H 1-6 mm, POM	022.0046, 022.0047, 022.0048, 022.0049, 022.0050
	025.4646-04*	RC Novaloc® Plan Abutment, H 1-6 mm, POM	022.0052, 022.0053, 022.0054, 022.0055, 022.0056, 022.0057



Straumann® Novaloc® Plan Abutments, angled, 15°

	Art. No.	Description	Compatibility with Novaloc® Abutments
	048.853V4	RN Novaloc® Plan Abutment, angled 15°, H 2-6mm, POM	048.832, 048.833, 048.834, 048.835, 048.836
	048.854V4	WN Novaloc® Plan Abutment, angled 15°, H 2-6mm, POM	048.837, 048.838, 048.839, 048.840, 048.841

Straumann® Novaloc® Plan Abutments, angled, 15°, Type A

	Art. No.	Description	Compatibility with Novaloc® Abutments
	048.855V4	NNC Novaloc® Plan Abutment, angled 15°, H 2-6mm, type A, POM	048.842, 048.843, 048.844, 048.845, 048.846
	025.0046V4	NC Novaloc® Plan Abutment, angled 15°, H 2-6mm, type A, POM	022.0062, 022.0063, 022.0064, 022.0065, 022.0066
	025.0045V4	RC Novaloc® Plan Abutment, angled 15°, H 2-6mm, type A, POM	022.0067, 022.0068, 022.0069, 022.0070, 022.0071

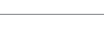
Straumann® Novaloc® Plan Abutments, angled, 15°, Type B

	Art. No.	Description	Compatibility with Novaloc® Abutments
	048.856V4	NNC Novaloc® Plan Abutment, angled 15°, H 2-6mm, type B, POM	048.847, 048.848, 048.849, 048.850, 048.851
	025.0048V4	NC Novaloc® Plan Abutment, angled 15°, H 2-6mm, type B, POM	022.0072, 022.0073, 022.0074, 022.0075, 022.0076
	025.0047V4	RC Novaloc® Plan Abutment, angled 15°, H 2-6mm, type B, POM	022.0077, 022.0078, 022.0079, 022.0080, 022.0081

*compatible to LOCATOR®

ADLC = Amorphous Diamond-Like Carbon

Not all products are available in all countries.

Retention Inserts











	Art. No.	Description	Material	Retention	Quantity
	2010.601-STM*/ 2010.601-NOV**	Novaloc® Processing Package			2 pcs
		Titanium Matrix Housing (including Processing Insert)	Titanium / POM		
		Retention Insert, white, light	PEEK	Light, approx. 750g	
		Retention Insert, yellow, medium		Medium, approx. 1200g	
		Retention Insert, green, strong	Strong, approx. 1650g		
Processing Collar, silicone	Silicone				
	2010.611-STM*/ 2010.611-NOV**	Novaloc® Processing Package PEEK			2 pcs
		PEEK Matrix Housing (including Processing Insert)	PEEK / POM		
		Retention Insert, white, light	PEEK	Light, approx. 750g	
		Retention Insert, yellow, medium		Medium, approx. 1200g	
		Retention Insert, green, strong	Strong, approx. 1650g		
Processing Collar	Silicone				
	2010.710-STM*/ 2010.710-NOV**	Novaloc® Retention Insert Red - Extra Light	PEEK	Extra-light, approx. 300g	4 pcs
	2010.711-STM*/ 2010.711-NOV**	Novaloc® Retention Insert White - Light		Light, approx. 750g	
	2010.712-STM*/ 2010.712-NOV**	Novaloc® Retention Insert Yellow - Medium		Medium, approx. 1200g	
	2010.713-STM*/ 2010.713-NOV**	Novaloc® Retention Insert Green - Strong		Strong, approx. 1650g	
	2010.714-STM*/ 2010.714-NOV**	Novaloc® Retention Insert Blue - Extra-Strong		Extra-strong, approx. 2100g	
	2010.715-STM*/ 2010.715-NOV**	Novaloc® Retention Insert Black - Ultra-Strong		Ultra-strong, approx. 2550g	

* Manufacturer
Valoc AG
Theodorshofweg 22, 4310 Rheinfelden
Switzerland

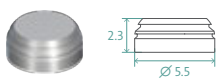
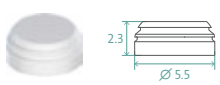
* Distributor
Institut Straumann AG
Peter Merian-Weg 12, 4002 Basel
Switzerland

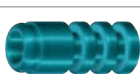
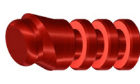
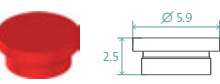
** Manufacturer & Distributor
Institut Straumann AG
Peter Merian-Weg 12, 4002 Basel
Switzerland

Auxiliaries

	Art. No.	Description	Material	Quantity
	2010.101-STM*/ 2010.101-NOV**	Novaloc® Equipment Box with 3 instruments		
		Processing Insert Removal Instrument	PP/PS/stainless steel/ Aluminium	
		Retention Insert Instrument		
		Matrix Housing Extraction Instrument		
	2010.731-STM*/ 2010.731-NOV**	Novaloc® Processing Insert Removal Instrument	Stainless steel/ Aluminium	1 pcs
	2010.741-STM*/ 2010.741-NOV**	Novaloc® Retention Insert Instrument		
	2010.751-STM*/ 2010.751-NOV**	Novaloc® Matrix Housing Extraction Instrument		
	2010.701-STM*/ 2010.701-NOV**	Novaloc® Matrix Housing (including Processing Insert)	Titanium/POM	4 pcs
	2010.702-STM*/ 2010.702-NOV**	Novaloc® Matrix Housing PEEK (including Processing Insert)	PEEK/POM	
	2010.703-STM*/ 2010.703-NOV**	Novaloc® Matrix Housing - Extended (including Processing Insert)	Titanium/POM	
	2010.721-STM*/ 2010.721-NOV**	Novaloc® Model Analog	Aluminium	
	2010.720-STM*/ 2010.720-NOV**	Novaloc® Model Analog - Angled 15°		
	2010.722-STM*/ 2010.722-NOV**	Novaloc® Impression Coping	PEEK	
	2010.723-STM*/ 2010.723-NOV**	Novaloc® Block Out Spacer	POM	
	2010.724-STM*/ 2010.724-NOV**	Novaloc® Processing Collar	Silicone	
	2010.725-STM*/ 2010.725-NOV**	Novaloc® Processing Insert	POM	4 pcs

* Manufacturer
Valoc AG
Theodorshofweg 22, 4310 Rheinfelden
Switzerland

* Distributor
Institut Straumann AG
Peter Merian-Weg 12, 4002 Basel
Switzerland

** Manufacturer & Distributor
Institut Straumann AG
Peter Merian-Weg 12, 4002 Basel
Switzerland.

6. Appendix

6.1 Appendix A

6.1.1 Chair-side modification of an existing lower denture into an overdenture supported by Novaloc® Abutments

For an existing well-fitting and well-functioning lower complete denture, the Novaloc® Retentive System can be used in a chair-side procedure.

Caution: It is a prerequisite however, that the lower complete denture does not need to be relined by a dental technician.

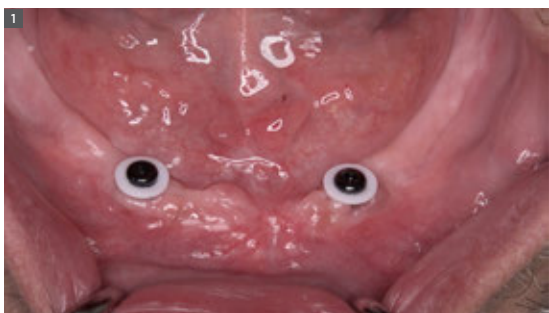

Place white Processing Collars on each Novaloc® Abutment. The Processing Collar are used to block out the area surrounding the abutments.

Caution: If the Novaloc® Processing Collars do not completely fill the space between the mucosa and the Matrix Housings any remaining undercuts must be blocked out to prevent resin flowing under the Matrix Housings. This can be accomplished by stacking two or more Processing Collars or a custom sized and pierced piece of rubber dam.

Then place a Matrix Housing with white Processing Insert onto each Novaloc® Abutment, leaving the white Processing Collar beneath it.



Prepare the lower complete denture to accommodate the Novaloc® Matrix Housings. Hollow out the existing denture base in the areas of the Novaloc® Matrix Housings with handpiece and resin bur.

Note: Novaloc® Block Out Spacers can be used instead of Matrix Housings to create the space needed in the denture.



Use wash impression silicone to confirm adequate clearance between the Matrix Housings and the denture base.



Insert the lower complete denture into the patient's mouth and check the clearance. The Matrix Housings fixed on the abutments should not touch the denture base. Reconfirm adequate space using wash impression silicone. Adjust the denture base until seated passively in occlusion without touching the Matrix Housings.

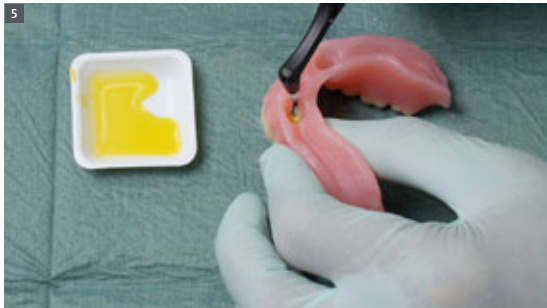

Prepare the recess in the lower complete denture with monomer. Protect areas where you don't want the resin with a thin layer of petroleum jelly.

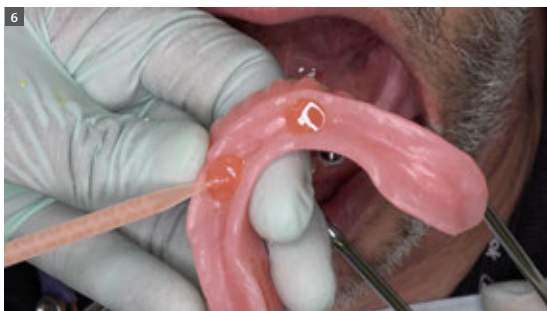

Fill the hollowed area with self-curing PMMA resin to polymerize the Matrix Housings in the denture.

Apply a small amount of acrylic resin to the recess of the denture base and around the Matrix Housings. Insert the lower complete denture into the oral cavity.

Once the lower complete denture is properly seated, maintain the patient in full occlusion while the acrylic sets.

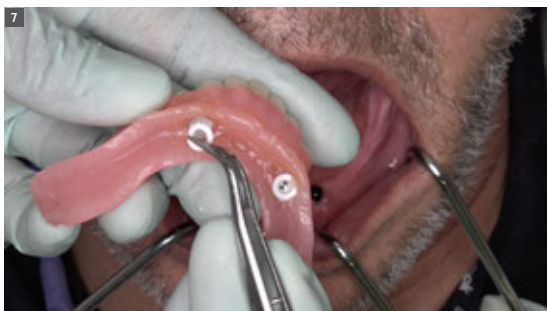

Once the resin has cured, remove the lower complete denture from the mouth and discard the white Novaloc® Processing Collars.

Put the lower complete denture in hot, but not boiling, water. Place it in a pressure pot when available.



After final curing, remove any excess acrylic and finish the denture base.

Exchange the Processing Inserts for the final Novaloc® Retention Inserts and insert the final overdenture into the patient's mouth.

6.2 Appendix B

6.2.1 Preparation for lab-side modification of an existing lower denture into an overdenture supported by Novaloc® Abutments

If the lower complete denture's fit is inadequate (poor adaptation to underlying tissue) after surgery and major adjustments are necessary, indirect relining of the mandibular denture is necessary. This means that relining and insertion of Novaloc® Matrix Housings incl. Processing Inserts are performed by the **dental technician** immediately after border mold impression-taking. Lab-side relining has to be planned in advance with your dental technician.

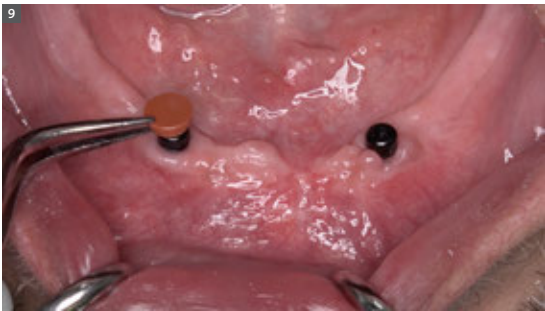

Place a Novaloc® Impression Coping onto each Novaloc® Abutment.



Hollow out the existing denture base in the areas of the Novaloc® Impression Copings with handpiece and resin bur.



Use wash impression silicone to confirm adequate clearance between the Impression Coping and the denture base.



Insert the lower complete denture into the patient's mouth and check the clearance. The Impression Coping on the abutments should not touch the denture base. Reconfirm space using wash impression silicone. Adjust the denture base to seat passively in occlusion without touching the Impression Coping.



Prepare the lower complete denture for **border mold impression technique**.

- Remove any undercuts from the denture base.
- Check for peripheral extensions and if necessary (optional) adjust them with thermo-plastic materials (border molding).
- Dry the inner surface of the mandibular denture with alcohol and apply the corresponding adhesive.

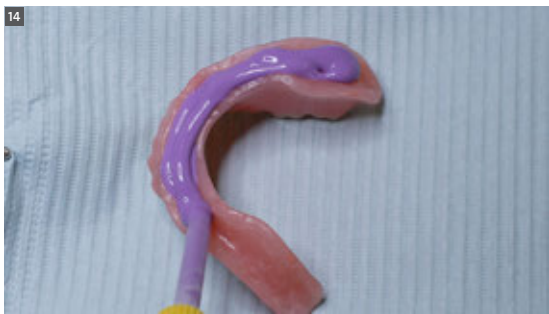

Take a reline impression.

Apply polyether impression material to the internal aspect of the lower complete denture, and take a reline impression with the patient in occlusion.





Once the impression material has cured, remove the lower complete denture with the Novaloc® Impression Copings from the mouth. If the Novaloc® Impression Copings did not remain inside the impression, carefully reseat them into the relined impression.

Send the mandibular denture to the dental technician to reline it, integrate the Matrix Housings and convert it into an overdenture. After having received the final overdenture from the **dental technician** exchange the Processing Inserts for the final Novaloc® Retention Inserts and insert the final overdenture into the patient's mouth.

International Headquarters

Institut Straumann AG

Peter Merian-Weg 12

CH-4002 Basel, Switzerland

Phone +41 (0)61 965 11 11

Fax +41 (0)61 965 11 01

www.straumann.com

Novaloc® is a registered trademark of Valoc AG, Switzerland.

© Institut Straumann AG, 2021. All rights reserved.

Straumann® and/or other trademarks and logos from Straumann® mentioned herein are the trademarks or registered trademarks of Straumann Holding AG and/or its affiliates. All rights reserved.